

## Features

- Fits minimum 36" apron sink base cabinet.
- 9-1/2"-deep single bowl.
- Shortened apron allows sink to be used in most standard cabinetry or retrofitted to existing standard cabinetry.
- Plain front design.
- Matte finish offers rich, dimensional color.
- Solid color throughout the sink.
- Scratch, stain, chip, and thermal-shock resistant.
- Offset drain increases workspace in the sink and storage space underneath.

## Material

- KOHLER Neoroc® composite is durable and built to withstand day-to-day cleaning tasks.
- Heat resistant up to 750°F.

## Installation

- Undermount.
- No faucet holes.
- Self-Trimming® apron overlaps the cabinet face for easy installation.

## Included Components

- K-26026 Farmhouse kitchen sink towel hook
- K-30182 Sink racks



## Codes/Standards







CSA B45.5/IAPMO Z124  
IAPMO Certification

## KOHLER® Neoroc® Sinks Lifetime Limited Warranty

See website for detailed warranty information.

## Available Colors/Finishes

*Color tiles intended for reference only.*

Color	Code	Description
	CM6	Matte White
	CM7	Matte Graphite
	CM1	Matte Black
	CM2	Matte Brown
	CM3	Matte Taupe
	CM4	Matte Grey

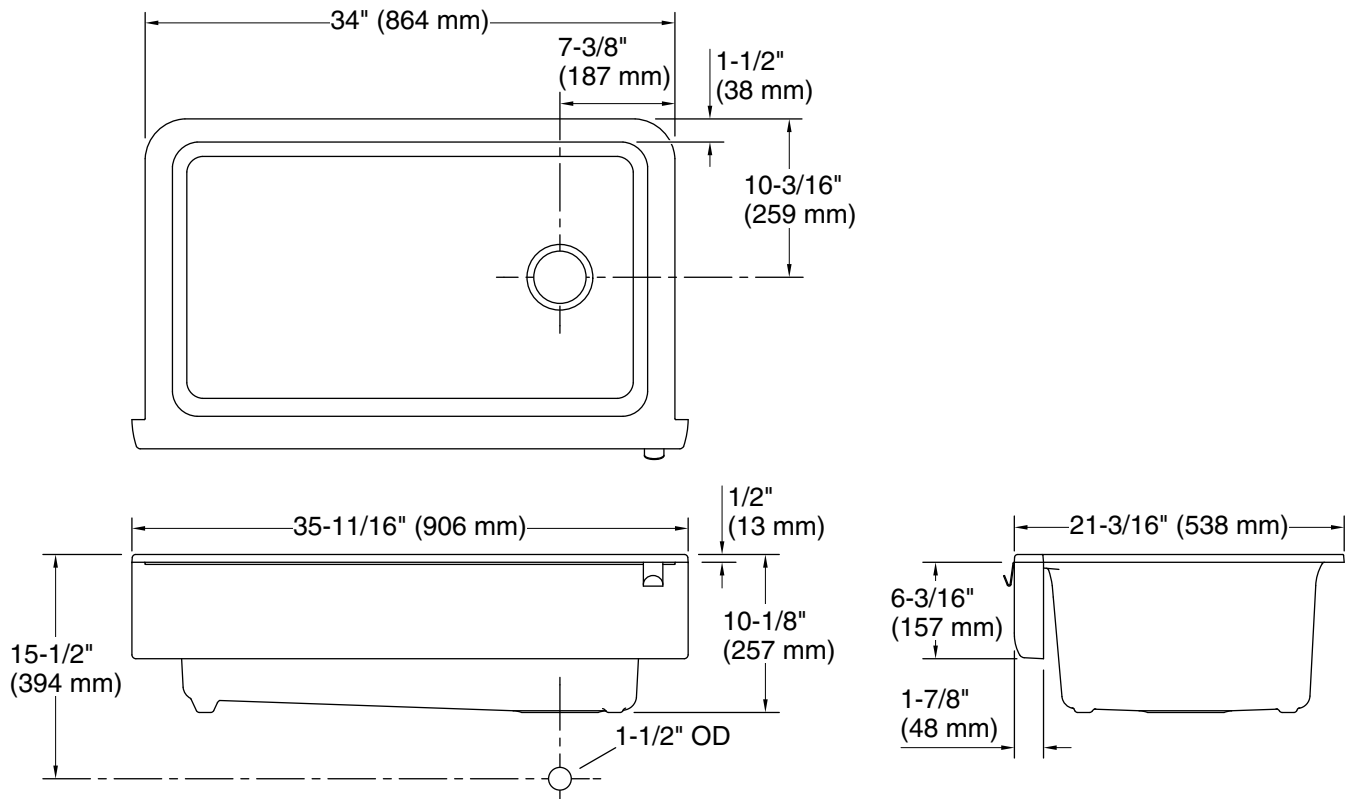

## Technical Information

All product dimensions are nominal.

Bowl configuration: Single

Min. base cabinet width: 36" (914 mm)

Bowl area (Only):  
 Length: 28-5/8" (726 mm)  
 Width: 15-1/2" (394 mm)  
 Bowl depth: 9-1/2" (241 mm)  
 Water depth: 9-1/2" (241 mm)

Drain hole: 3-7/8" (98 mm)

Template: Apron-front, 1400299-7, required, included

## Notes

Install this product according to the installation instructions.